

RoHS  Lead-free

NOTES:

1. Material: Nylon66, UL94V-0
2. Color: White
3. Current Rating: 1A AC,DC
4. Voltage Rating: 50V AC,DC
5. Temperature Rang: -25°C~+85°C
6. Contact Resistance: 30mΩ Max
7. Insulation Resistance: 100MΩ Min
8. Withstanding Voltage: 500V AC/minute

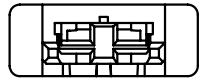

02P

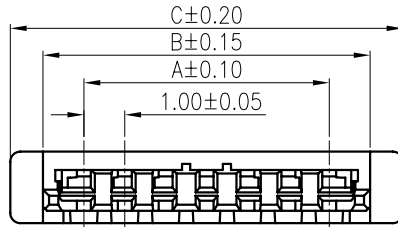

03.05.07.09.11.13.15P

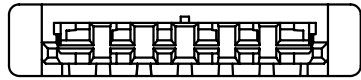

06.08.10.12.14.16.20.22.26.30P

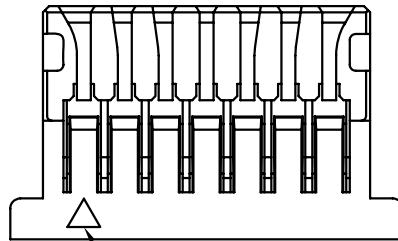

Circuit 1

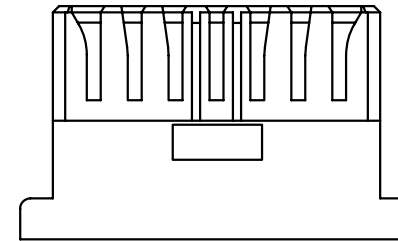
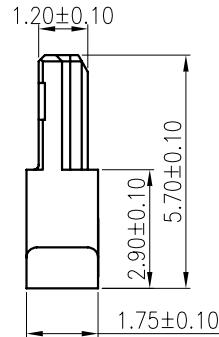

PIN	Dimension(mm)		
	A	B	C
02		3.00	4.60
03	2.00	4.00	5.60
04	3.00	5.00	6.60
05	4.00	6.00	7.60
06	5.00	7.00	8.60
07	6.00	8.00	9.60
08	7.00	9.00	10.60
09	8.00	10.00	11.60
10	9.00	11.00	12.60
11	10.00	12.00	13.60
12	11.00	13.00	14.60
13	12.00	14.00	15.60
14	13.00	15.00	16.60
15	14.00	16.00	17.60
16	15.00	17.00	18.60
20	19.00	21.00	22.60
22	21.00	23.00	24.60
26	25.00	27.00	28.60
30	29.00	31.00	32.60



2018/3/08	G	H		Modify the size C And D	wuxiaotao	Jova	GENERAL TOLERANCE .X ±0.30 .XX ±0.20 .XXX ±0.10	东莞市翰皓精密电子有限公司 DONGGUAN HANHAO PRECISION ELECTRONIC CO.,LTD				PART NO. J1005H-XX			
2017/9/28	F	G		Space of a Whole page Changes	Jova	Bob						TITLE 1.00mm Crimp Style Connectors			
2017/8/22	E	F	ECN2014043001	Increase the @ @ number of dimensions	Bob	Bob		APPROVAL	CHECK	DRAWN	DATA	UNIT MM	SCALE 1:1	NUMBER A-106	REV H
DATE	OLD REV	NEW REV	ECN	DESCRIPTION	CHECK	APPROVAL	PROJECT	Kim Huang	Jova Lau	Xiaowx	2017/8/22				

RoHS  Lead-free

F
E
D
C
B

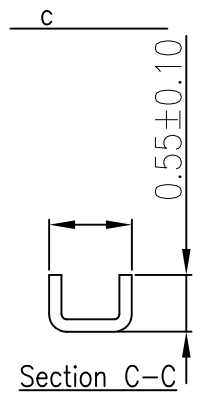
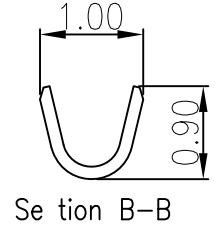
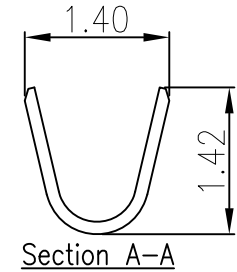
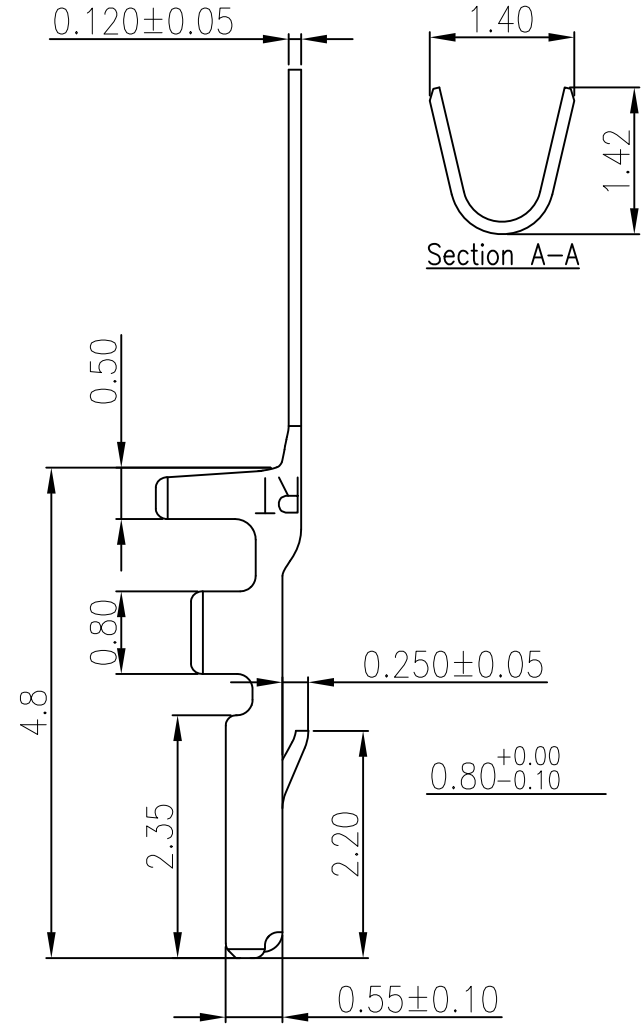
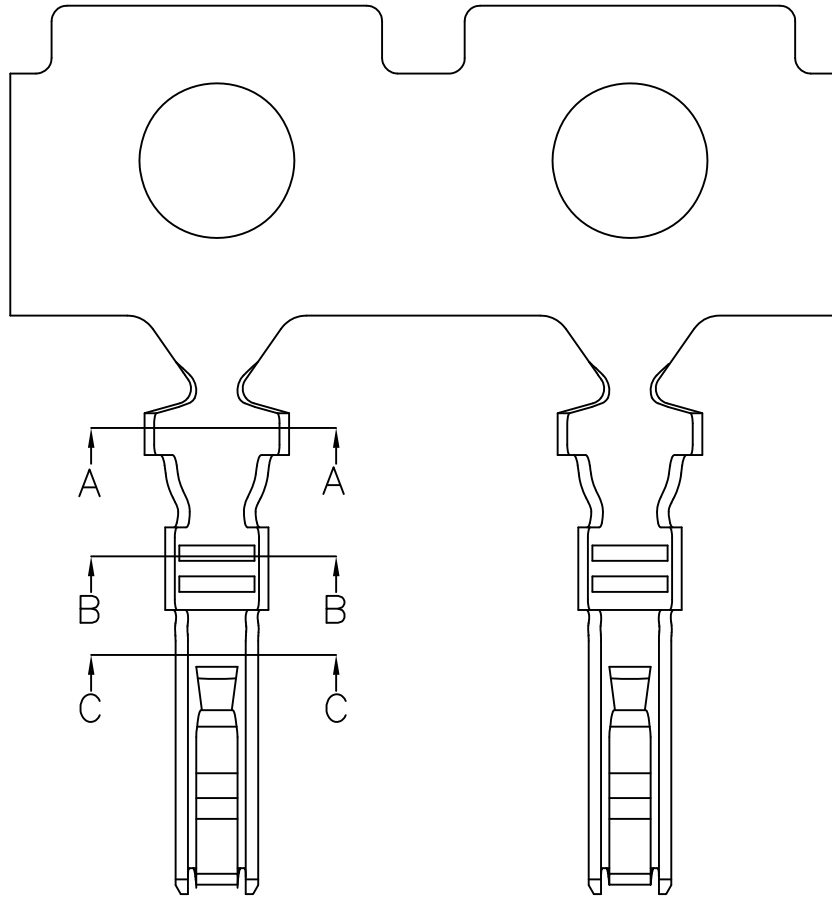

- NOTES:
1. Material: Phosphor Bronze, T=0.12mm
 2. Finish: TPE-Tin Plated Over Nickel.
GPE-Gold Flash Over Nickel.
G1PE-Gold 1u" Over Nickel.
G3PE-Gold 3u" Over Nickel.
G5PE-Gold 5u" Over Nickel.
G15PE-Gold 15u" Over Nickel.
 3. Applicable Wire Range: AWG#28~#34
 4. Insulation O.D.: 0.80mm (Max.)
 5. Current Rating: 1A AC,DC
 6. Voltage Rating: 50V AC,DC
 7. Temperature Rang: -25°C~+85°C
 8. Contact Resistance: 30mΩ Max
 9. Insulation Resistance: 100MΩ Min
 10. Withstanding Voltage: 500V AC/minute

2018/3/08	G	H		Modify the size C And D	wuxiaotao	Jova	GENERAL TOLERANCE .X ±0.30 .XX ±0.20 .XXX ±0.10	东莞市翰皓精密电子有限公司 DONGGUAN HANHAO PRECISION ELECTRONIC CO.,LTD				PART NO. J1005T			
2017/9/28	F	G		Space of a Whole page Changes	Jova	Bob						TITLE 1.00mm Crimp Style Connectors			
2017/8/22	E	F	ECN2014043001	Increase the @ @ number of dimensions	Bob	Bob		APPROVAL	CHECK	DRAWN	DATA	UNIT	SCALE	NUMBER	REV
DATE	OLD REV	NEW REV	ECN	DESCRIPTION	CHECK	APPROVAL		PROJECT	Kim Huang	Jova Lau	Xiaowx	2017/8/22	MM	1:1	A-106

1 2 3 4 5 6 7 8

RoHS

本产品符合我司QA-3-04-005
环境管理物质标准规范

工程图

Specifications :

- Voltage rating: 50V AC / DC
- Current rating: 1A AC / DC
- Withstanding voltage: 500V AC/minute
- Temperature range: -25°C~+85°C
- Insulation resistance: ≥100MΩ
- Contact resistance: ≤20mΩ
- After environmental testing: ≤40mΩ

- Material(Pin): Phosphor Bronze
- Material(Solder Tabs): Phosphor Bronze
- Mates With HLB Housing: 1005H

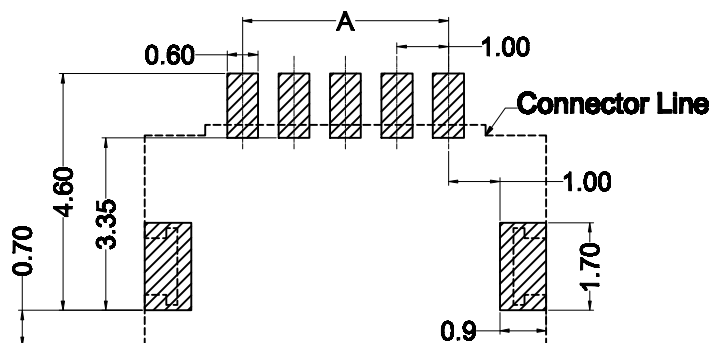
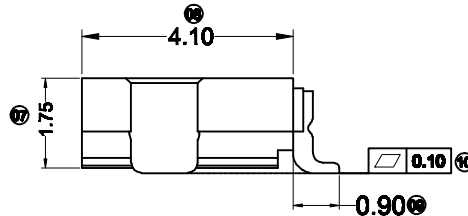
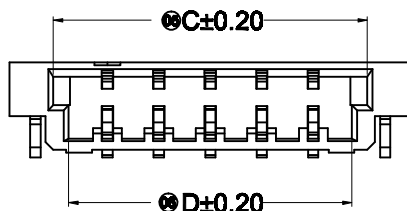
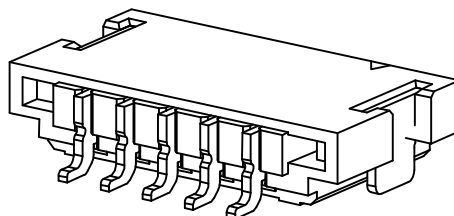
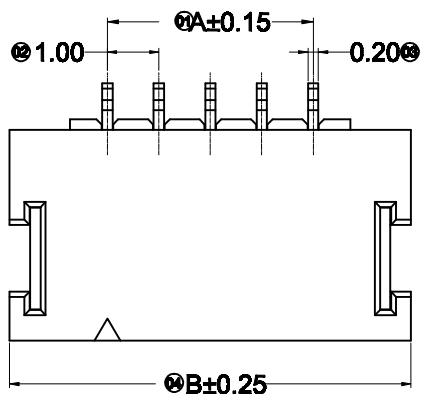

Recommended P.C.B Layout
General Tolerance ±0.05

Poles	Dimensions(mm)				Poles	Dimensions(mm)			
	A	B	C	D		A	B	C	D
02	1.00	4.00	3.10	2.50	17	16.00	19.00	18.10	17.00
03	2.00	5.00	4.10	3.50	18	17.00	20.00	19.10	18.00
04	3.00	6.00	5.10	4.50	19	18.00	21.00	20.10	19.00
05	4.00	7.00	6.10	5.50	20	19.00	22.00	21.10	20.00
06	5.00	8.00	7.10	6.50	21	20.00	23.00	22.10	21.00
07	6.00	9.00	8.10	7.50	22	21.00	24.00	23.10	22.00
08	7.00	10.00	9.10	8.50	23	22.00	25.00	24.10	23.00
09	8.00	11.00	10.10	9.50	24	23.00	26.00	25.10	24.00
10	9.00	12.00	11.10	10.50	25	24.00	27.00	26.10	25.00
11	10.00	13.00	12.10	11.50	26	25.00	28.00	27.10	26.00
12	11.00	14.00	13.10	12.50	27	26.00	29.00	28.10	27.00
13	12.00	15.00	14.10	13.50	28	27.00	30.00	29.10	28.00
14	13.00	16.00	15.10	14.50	29	28.00	31.00	30.10	29.00
15	14.00	17.00	16.10	15.50	30	29.00	32.00	31.10	30.00
16	15.00	18.00	17.10	16.50					

J1005WRS-XX	PA9T UL 94V-0	Phosphor bronze	Gold-Flesh	Brass	Tin	J1005H
PART NO	Material	Material(Pin)	Finish(Pin)	Material (Solder Tabs)	Finish (Solder Tabs)	Mates With HLB Housing

							未标注公差	东莞市翰皓精密电子有限公司				料号: J1005WRS-XX					
							X ±0.20	DONGGUAN HANHAO PRECISION ELECTRONIC CO.,LTD				名称: 1.00 mm Crimp Style Connectors					
							.XX ±0.15	核准	审查	制作	日期						
							.XXX ±0.08					Yu wei	2017/06/05	单位: MM	比例: 1:1	供应商编号: A-100	版本: A
日期	旧版本	新版本	变更编号	内容	审查	核准											