

环保物料

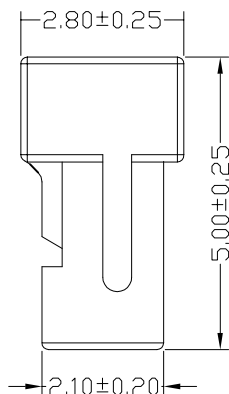
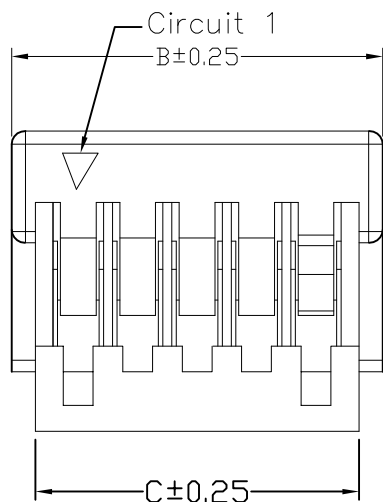
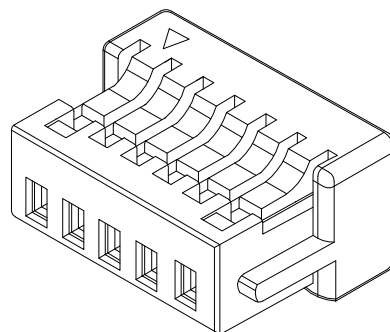
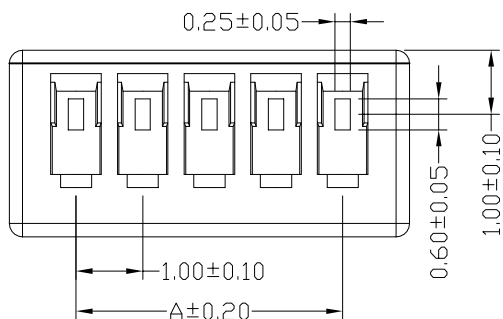

■ Specifications(规格) :

- Voltage rating(额定电压): 50V AC / DC
- Current rating(额定电流): 1A AC / DC
- Withstanding voltage(耐压值): 500V AC/minute
- Temperature range(工作温度): -25°C~+85°C
- Insulation resistance(绝缘电阻): ≥100MΩ
- Contact resistance(接触电阻): ≤20mΩ
- After environmental testing(环境测试后): ≤30mΩ

■ Housing(胶壳)

- Part No. (料号) :J1001HE-XXP
- Poles (PIN数) : 02-24
- Material (材质) : PBT UL 94V-0
- Suitable HLB J1001T Series Terminal(匹配J1001T系列端子)
- Mates With HLB J1001W、J1001WR Series Wafer (匹配J1001W、J1001WR系列针座)
- Q'ty (数量) : 1,000Pcs/Bag/每袋 (1,000Pcs)

Poles	PART NO.	Dimensions (mm)			Poles	PART NO.	Dimensions (mm)		
		A	B	C			A	B	C
02	J1001H-02P	1.00	3.00	2.40	12	J1001H-12P	11.00	13.00	13.40
03	J1001H-03P	2.00	4.00	3.40	13	J1001H-13P	12.00	14.00	14.40
04	J1001H-04P	3.00	5.00	4.40	14	J1001H-14P	13.00	15.00	15.40
05	J1001H-05P	4.00	6.00	5.40	15	J1001H-15P	14.00	16.00	16.40
06	J1001H-06P	5.00	7.00	6.40	16	J1001H-16P	15.00	17.00	17.40
07	J1001H-07P	6.00	8.00	7.40	17	J1001H-17P	16.00	18.00	18.40
08	J1001H-08P	7.00	9.00	8.40	18	J1001H-18P	17.00	19.00	19.40
09	J1001H-09P	8.00	10.00	9.40	19	J1001H-19P	18.00	20.00	20.40
10	J1001H-10P	9.00	11.00	10.40	20	J1001H-20P	19.00	21.00	22.40
11	J1001H-11P	10.00	12.00	11.40	24	J1001H-24P	23.00	25.00	24.40

						一般公差 GENERAL TOLERANCE		东莞市翰皓精密电子有限公司 Dongguan HanHao Precision Electronics Co.,Ltd				料号 PART NO J1001HE-XXP				
						.X ±0.3 .XX ±0.2 .XXX ±0.1						品名 TITLE 1.00 mm Crimp Style connectors				
2011/05/14	A	B	修改图框格式					核准 APPD	审核 CHK	绘图 DR	日期 DATA	单位 UNIT	比例 SCALE	图号 NUMBER	版次 REV	
日期 DATE	旧版次 OLD REV	新版次 NEW REV	变更内容 DESCRIPTION			审核 CHK	核准 APPD	角法	PROJECT	SUCCESS	刘艳	2007/05/03	MM	1/1	A-106	B

环保物料

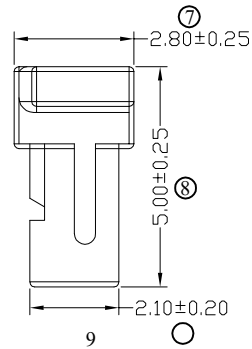
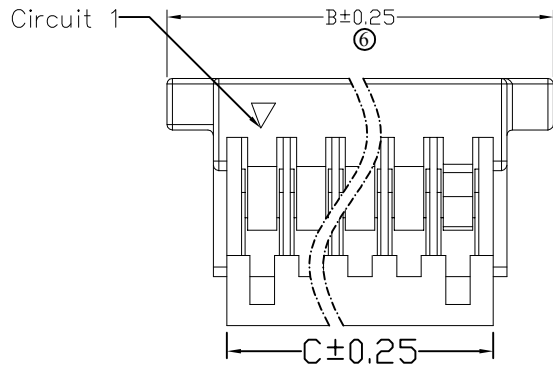
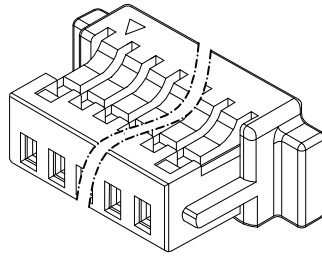
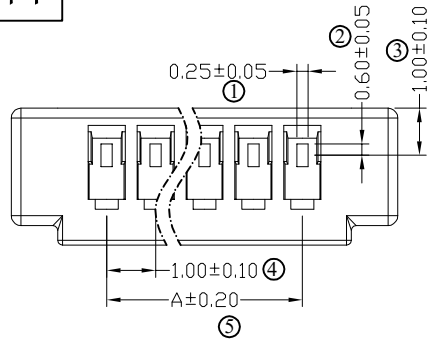

■ Specifications(规格) :

- Voltage rating(额定电压) : 50V AC / DC
- Current rating(额定电流) : 1A AC / DC
- Withstanding voltage(耐压值) : 500V AC/minute
- Temperature range(工作温度) : -25°C~+85°C
- Insulation resistance(绝缘电阻) :  $\geq 100M\Omega$
- Contact resistance(接触电阻) :  $\leq 20m\Omega$
- After environmental testing(环境测试后) :  $\leq 30m\Omega$

■ Housing(胶壳)

- Part No. (料号) : J1001H-XXP
- Poles (PIN数) : 02-24
- Material (材质) : PBT UL 94V-0
- Suitable HLB J1001T Series Terminal(匹配J1001T系列端子)
- Mates With HLB J1001W、J1001WR Series Wafer (匹配J1001W、J1002WR系列针座)
- Q' ty (数量) : 1,000Pcs/Bag/每袋 (1,000Pcs)

Part No.	Dimensions (mm)			Part No.	Dimensions (mm)		
	A	B	C		A	B	C
1002H00-02P-E	1.00	5.00	2.40	1002H00-13P-E	12.00	16.00	13.40
1002H00-03P-E	2.00	6.00	3.40	1002H00-14P-E	13.00	17.00	14.40
1002H00-04P-E	3.00	7.00	4.40	J1001H-1*15	14.00	18.00	15.40
1002H00-05P-E	4.00	8.00	5.40	1002H00-16P-E	15.00	19.00	16.40
1002H00-06P-E	5.00	9.00	6.40	1002H00-17P-E	16.00	20.00	17.40
1002H00-07P-E	6.00	10.00	7.40	1002H00-18P-E	17.00	21.00	18.40
1002H00-08P-E	7.00	11.00	8.40	1002H00-19P-E	18.00	22.00	19.40
1002H00-09P-E	8.00	12.00	9.40	1002H00-20P-E	19.00	23.00	20.40
1002H00-10P-E	9.00	13.00	10.40	1002H00-22P-E	21.00	25.00	22.40
1002H00-11P-E	10.00	14.00	11.40	1002H00-24P-E	23.00	27.00	24.40
1002H00-12P-E	11.00	15.00	12.40				

				一般公差 GENERAL TOLERANCE				东莞市翰皓精密电子有限公司 Dongguan HanHao Precision Electronics Co.,Ltd				料号 PART NO J1001H-XXP				
				.X ±0.3 .XX ±0.2 .XXX ±0.1				核准 APPD 审核 CHK 绘图 DR 日期 DATA				品名 TITLE 1.00 mm Crimp Style connectors				
2011/05/14	A	B	修改图框格式													
日期 DATE	旧版次 OLD REV	新版次 NEW REV	变更内容 DESCRIPTION			审核 CHK	核准 APPD	角法 PROJECT	DONGKUN	SUCCESS	刘艳	2007/05/03	单位 UNIT MM	比例 SCALE 1/1	图号 NUMBER A-003	版次 REV B

环保物料

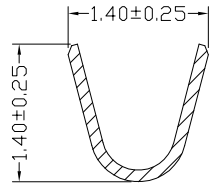
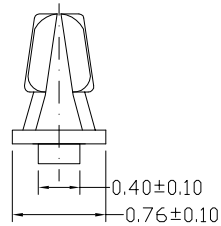
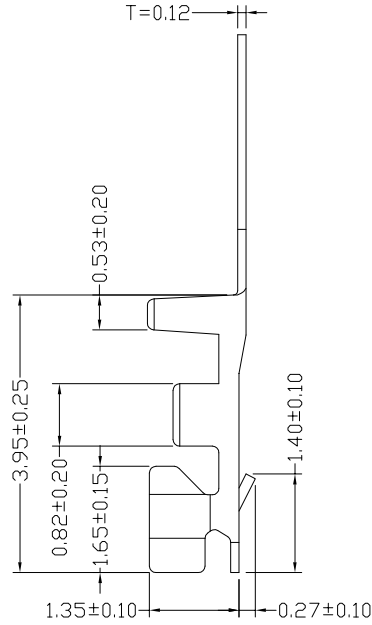
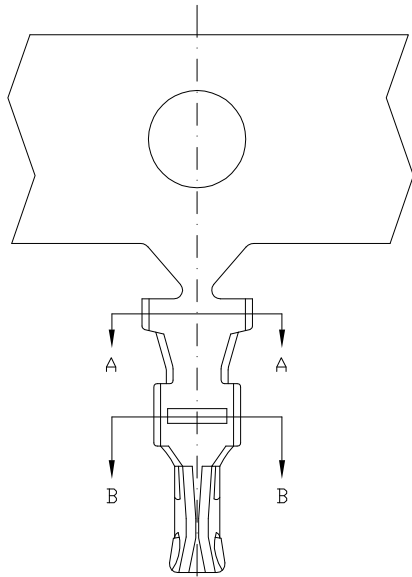

Section: A-A

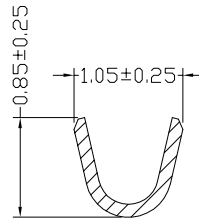

Section: B-B

Specifications

- Voltage Rating: 50V AC/ DC
- Current Rating: 1A AC/DC
- Withstanding Voltage: 500V AC/Minute.
- Insulation Resistance: 100MΩ Min.
- Temperature Range: -25°C~+85°C
- Contact Resistance: 20mΩ Max.

Terminal

- Part No.: 1001T/TG
- Applicable Wire: AWG#28-32
- Material: Phosphor Bronze
- Finish: Gold plated or Tin Plated
- Used in J1001 J1002 Series Housing
- Q'ty: 20,000 Pcs/Reel

				一般公差 GENERAL TOLERANCE				东莞市翰皓精密电子有限公司 Dongguan HanHao Precision Electronics Co.,Ltd				料号 PART NO J1001T						
				. X ±0.3 . XX ±0.2 . XXX ±0.1				核准 APPD 审核 CHK 绘图 DR 日期 DATA				品名 TITLE 1.00 mm Crimp Style connectors						
2011/05/14	A	B	修改图框格式				SUCCESS 刘艳 2007/05/03				单位 UNIT MM		比例 SCALE 1/1		图号 NUMBER A-003		版次 REV B	
日期 DATE	旧版次 OLD REV	新版次 NEW REV	变更内容 DESCRIPTION				审核 CHK		核准 APPD		PROJECT							

环保物料

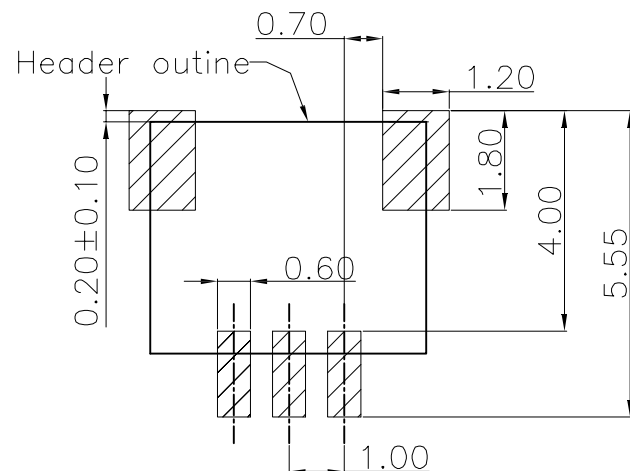
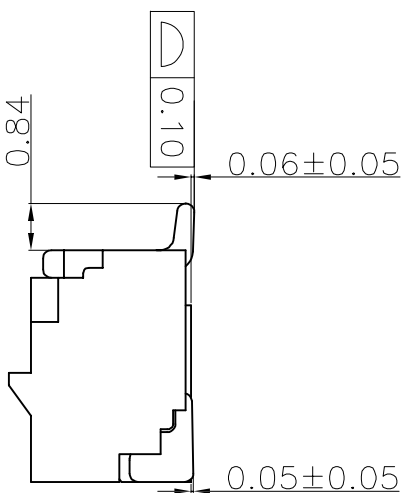
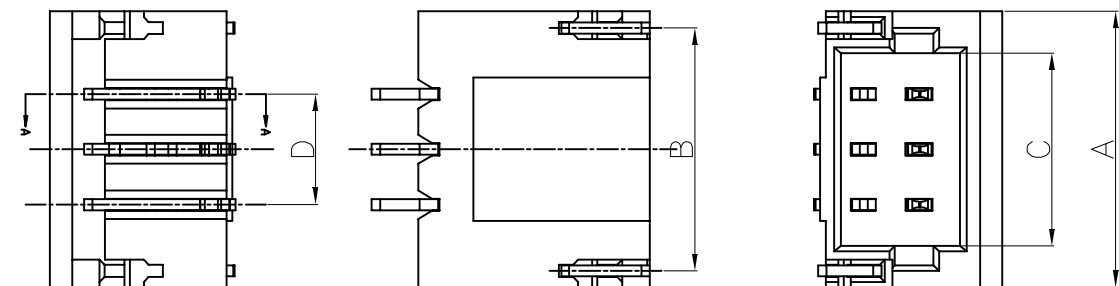

RECOMMENDED P.C.B HOLE LAYOUT  
TOP VIEW (TOLERANCE:±0.05)

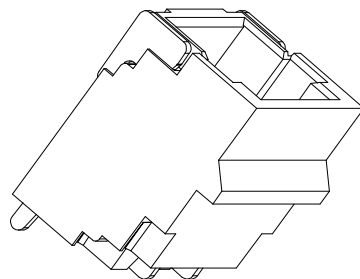

NOTE:  
1. WAFER  
PART NO.: J1001WRA-XX  
HOUSING: PA46  
COLOR:NATURE  
TERMINAL:C2680  
LATCH:C2680  
MATES WITH HHB J1001H SERIES HOUSING  
(匹配J1001H系列胶壳)

2. PLATING:  
CONTACT AREA:TIN(亮锡) PLATED  
SOLDER TAIL:TIN(亮锡) PLATED  
BOTTOM LOCK; TIN(亮锡) PLATED  
TOP LATCH:TIN(亮锡) PLATED

3. ELECTRICAL SPECIFICATION:  
CURRENT RATING:0.8 AMPERE PER CONTACT  
CONTACT RESISTANCE:40 MILLIOHMS MAX.  
INSULATION RESISTANCE:100 MEGOHMS MIN.  
DIELECTRIC WITHSTANDING VOLTAGE:200 VAC.  
OPERATING TEMPERATURE:-40C~+80C°

No. of pin	Part No.	DIMENSION (mm)			
		A	B	C	D
2	J1001WRA-02	4.00	3.40	2.50	1.00
3	J1001WRA-03	5.00	4.40	3.50	2.00
4	J1001WRA-04	6.00	5.40	4.50	3.00
5	J1001WRA-05	7.00	6.40	5.50	4.00
6	J1001WRA-06	8.00	7.40	6.50	5.00
7	J1001WRA-07	9.00	8.40	7.50	6.00
8	J1001WRA-08	10.00	9.40	8.50	7.00
9	J1001WRA-09	11.00	10.40	9.50	8.00
10	J1001WRA-10	12.00	11.40	10.50	9.00
11	J1001WRA-11	13.00	12.40	11.50	10.00
12	J1001WRA-12	14.00	13.40	12.50	11.00

一般公差  
GENERAL TOLERANCE  
.X ±0.3  
.XX ±0.2  
.XXX ±0.1

东莞市翰皓精密电子有限公司  
Dongguan Han Hao Precision Electronics Co.,Ltd

核准 APPD 审核 CHK 绘图 DR 日期 DATA

料号 PART NO  
J1001WRA-XX

品名 TITLE  
1.00 mm Crimp Style connectors

单位 UNIT 比例 SCALE 图号 NUMBER 版次 REV  
MM 1/1 A-032 B

2011/05/19	A	B	修改图框格式		
日期 DATE	旧版次 OLD REV	新版次 NEW REV	变更内容 DESCRIPTION	审核 CHK	核准 APPD

角法 PROJECT

2011/05/19

环保物料

F  
E  
D  
C  
B  
A

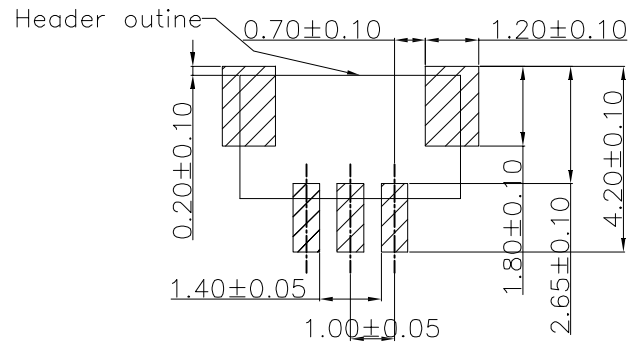
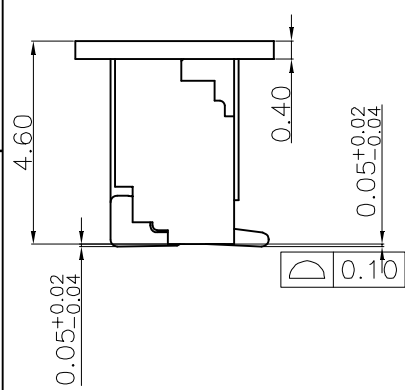

RECOMMENDED P.C.B HOLE LAYOUT  
TOP VIEW (TOLERANCE:±0.05)

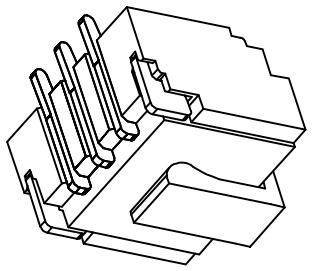
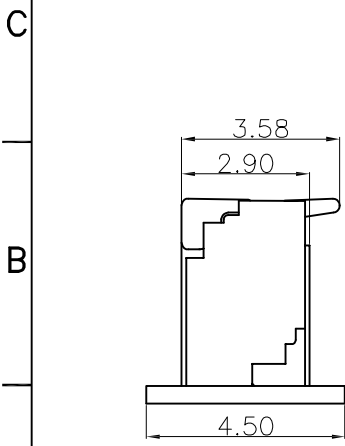
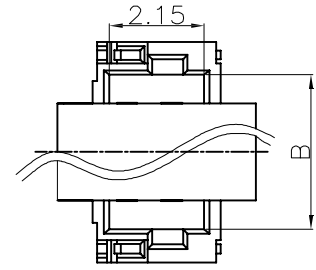
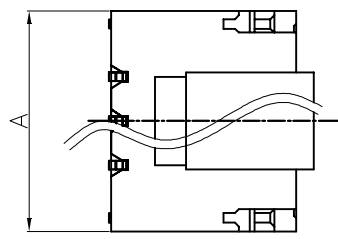
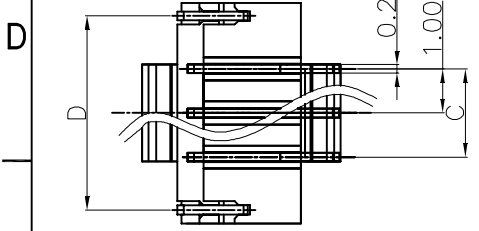

- NOTE:
- WAFER  
PART NO.: J1001WA-XX  
HOUSING: PA46  
COLOR:NATURE  
TERMINAL:C2680  
LATCH:C2680  
MATES WITH HHB J1001H SERIES HOUSING  
(匹配J1001H系列胶壳)
  - PLATING:  
CONTACT AREA:TIN(亮锡) PLATED  
SOLDER TAIL:TIN(亮锡) PLATED  
BOTTOM LOCK: TIN(亮锡) PLATED  
TOP LATCH:TIN(亮锡) PLATED
  - ELECTRONICAL SPECIFICATION:  
CURRENT RATING:0.8 AMPERE PER CONTACT  
CONTACT RESISTANCE:40 MILLIOHMS MAX.  
INSULATION RESISTANCE:100 MEGOHMS MIN.  
DIELECTRIC WITHSTANDING VOLTAGE:200 VAC.  
OPERATING TEMPERATURE:-40C~+80C

NO. of pin	Part No.	DIMENSION (mm)			
		A	B	C	D
2	J1001WA-02	4.00	2.50	1.00	3.40
3	J1001WA-03	5.00	3.50	2.00	4.40

一般公差 GENERAL TOLERANCE		东莞市翰皓精密电子有限公司 Dongguan Han Hao Precision Electronics Co.,Ltd				料号 PART NO J1001WA-XX				
.X	±0.3	核准 APPD		审核 CHK	绘图 DR	日期 DATA	品名 TITLE 1.00 mm Crimp Style connectors			
.XX	±0.2	变更内容 DESCRIPTION		审核 CHK	核准 APPD	2011/05/19	单位 UNIT	比例 SCALE	图号 NUMBER	版次 REV
.XXX	±0.1	日期 DATE		旧版次 OLD REV	新版次 NEW REV		MM	1/1	A-032	B

2011/05/19	A	B	修改图框格式			
日期 DATE	旧版次 OLD REV	新版次 NEW REV	变更内容 DESCRIPTION		审核 CHK	核准 APPD

1 2 3 4 5 6 7 8

F  
E  
D  
C  
B  
A

环保物料

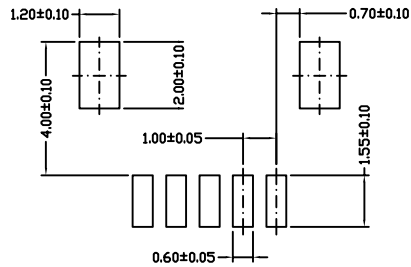
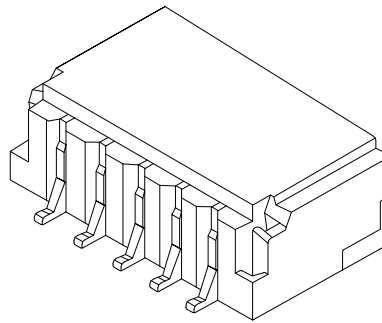
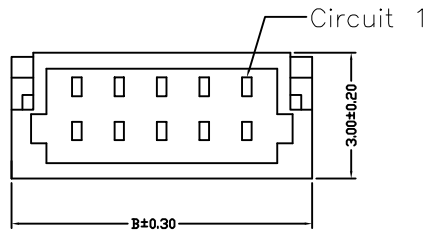
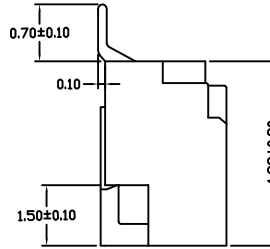
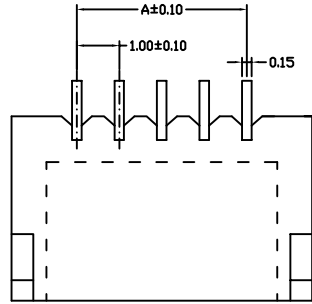

Recommant PCB Layout

■ Specifications(规格) :

- Voltage rating(额定电压) : 50V AC / DC
- Current rating(额定电流) : 1A AC / DC
- Withstanding voltage(耐压值) : 500V AC/minute
- Temperature range(工作温度) : -25°C~+85°C
- Insulation resistance(绝缘电阻) : ≥100MΩ
- Contact resistance(接触电阻) : ≤20mΩ
- After environmental testing(环境测试后) : ≤30mΩ

■ Wafer(针座)

- Part No. (料号) J1001WRS-XXP
- Poles (PIN数) : 02-24
- Material (材质) : Housing(胶壳) : Nylon 6T (尼龙6T) UL 94V-0  
Pin针: Phosphor Bronze (磷青铜)  
Finish (电镀) : Tin-Plated (镀锡)
- Mates With HLB J1001H Series Housing (匹配J1001H系列胶壳)

Part No.	Dimensions (mm)		Part No.	Dimensions (mm)	
	A	B		A	B
J1001WRS-02P	1.00	4.05	J1001WRS-12P	11.00	14.05
J1001WRS-03P	2.00	5.05	J1001WRS-13P	12.00	15.05
J1001WRS-04P	3.00	6.05	J1001WRS-14P	13.00	16.05
J1001WRS-05P	4.00	7.05	J1001WRS-15P	14.00	17.05
J1001WRS-06P	5.00	8.05	J1001WRS-16P	15.00	18.05
J1001WRS-07P	6.00	9.05	J1001WRS-17P	16.00	19.05
J1001WRS-08P	7.00	10.05	J1001WRS-18P	17.00	20.05
J1001WRS-09P	8.00	11.05	J1001WRS-19P	18.00	21.05
J1001WRS-10P	9.00	12.05	J1001WRS-20P	19.00	22.05
J1001WRS-11P	10.00	13.05	J1001WRS-24P	23.00	26.00

						<p>一般公差 GENERAL TOLERANCE</p> <p>. X ±0.3</p> <p>. XX ±0.2</p> <p>. XXX ±0.1</p>				<p>东莞市翰皓精密电子有限公司 Dongguan HanHao Precision Electronics Co.,Ltd</p>				<p>料号 PART NO J1001WRS-XXP</p>											
2011/05/14						A				B				修改图框格式											
日期 DATE						旧版次 OLD REV				新版次 NEW REV				变更内容 DESCRIPTION				审核 CHK				核准 APPD			
						角法 PROJECT				SUCCESS				刘艳				2007/05/03							
										核准 APPD				审核 CHK				绘图 DR				日期 DATA			
										单位 UNIT				比例 SCALE				图号 NUMBER				版次 REV			
										MM				1/1				A-032				B			

环保物料

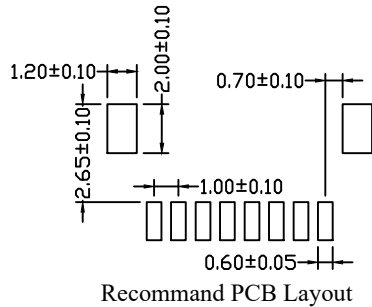
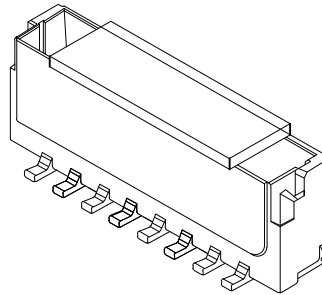
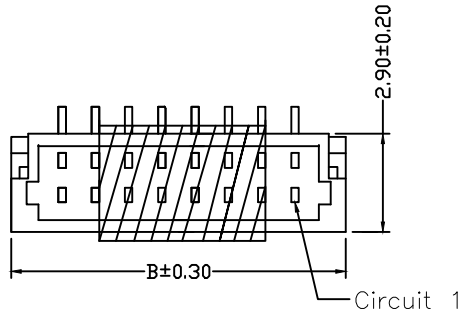
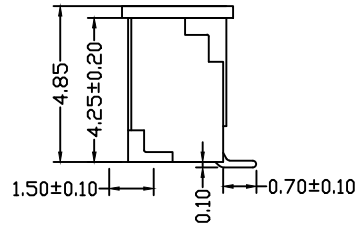
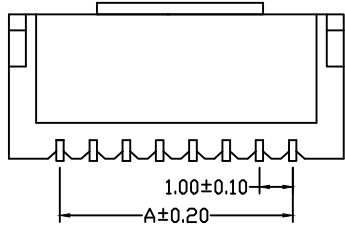

■ Specifications(规格) :

- Voltage rating(额定电压): 50V AC / DC
- Current rating(额定电流): 1A AC / DC
- Withstanding voltage(耐压值): 500V AC/minute
- Temperature range(工作温度): -25°C~+85°C
- Insulation resistance(绝缘电阻): ≥100MΩ
- Contact resistance(接触电阻): ≤20mΩ
- After environmental testing(环境测试后): ≤30mΩ

■ Wafer(针座)

- Part No. (料号) : J1001WS-XXP
- Poles (PIN数) : 02-24
- Material (材质) : Housing(胶壳) : Nylon 6T (尼龙6T) UL 94V-0  
Cap (盖子) : Nylon 6T (尼龙6T) UL 94V-0  
Pin针: Phosphor Bronze (磷青铜)  
Finish (电镀) : Tin-Plated (镀锡)  
Solder Tabs: Phosphor Bronze (磷青铜)  
Finish (电镀) : Tin-Plated (镀锡)
- Mates With HLB J1001H-XXP Series Housing (匹配J1001H-XXP系列胶壳)

Part No.	Dimensions (mm)		Part No.	Dimensions (mm)	
	A	B		A	B
J1001WS-02P	1.00	4.00	J1001WS-12P	11.00	14.00
J1001WS-03P	2.00	5.00	J1001WS-13P	12.00	15.00
J1001WS-04P	3.00	6.00	J1001WS-14P	13.00	16.00
J1001WS-05P	4.00	7.00	J1001WS-15P	14.00	17.00
J1001WS-06P	5.00	8.00	J1001WS-16P	15.00	18.00
J1001WS-07P	6.00	9.00	J1001WS-17P	16.00	19.00
J1001WS-08P	7.00	10.00	J1001WS-18P	17.00	20.00
J1001WS-09P	8.00	11.00	J1001WS-19P	18.00	21.00
J1001WS-10P	9.00	12.00	J1001WS-20P	19.00	22.00
J1001WS-11P	10.00	13.00	J1001WS-24P	23.00	26.00

				一般公差 GENERAL TOLERANCE		东莞市翰皓精密电子有限公司 Dongguan HanHao Precision Electronics Co.,Ltd				料号 PART NO J1001WS-XXP			
				. X ±0.3 . XX ±0.2 . XXX ±0.1		核准 APPD 审核 CHK 绘图 DR 日期 DATA				品名 TITLE 1.00 mm Crimp Style connectors			
2011/05/14	A	B	修改图框格式			SUCCESS				单位 UNIT 比例 SCALE 图号 NUMBER 版次 REV MM 1/1 A-003 B			
日期 DATE	旧版次 OLD REV	新版次 NEW REV	变更内容 DESCRIPTION			审核 CHK	核准 APPD	角法 PROJECT		刘艳		2007/05/03	

环保物料

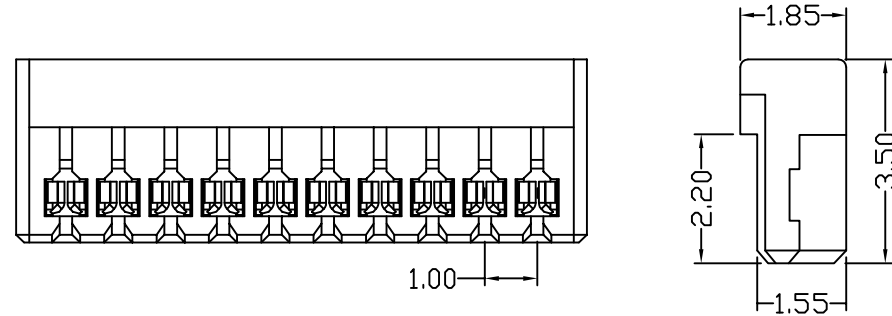
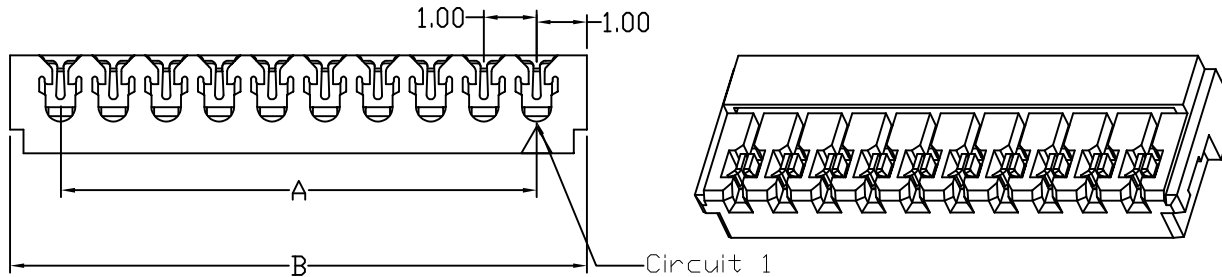

■ Specifications(规格) :

- Voltage rating(额定电压): 30V AC / DC
- Current rating(额定电流): 0.5A AC / DC
- Withstanding voltage(耐压值): 200V AC/minute
- Temperature range(工作温度): -25°C~+85°C
- Insulation resistance(绝缘电阻):  $\geq 100M\Omega$
- Contact resistance(接触电阻):  $\leq 20m\Omega$
- After environmental testing(环境测试后):  $\leq 30m\Omega$

■ Housing(胶壳)

- Part No. (料号) J1001HC-XXP
- Poles (PIN数) : 02-14
- Material (材质) : Nylon 46 (尼龙46) UL 94V-0
- Mates With HLB J1001 Series Wafer (匹配J1001系列针座)
- Q'ty (数量) : 1,000Pcs/Bag/每袋 (1,000Pcs)

PART NO.	Dimensions (mm)	
	A	B
J1001HC-02P	1.00	3.00
J1001HC-03P	2.00	4.00
J1001HC-04P	3.00	5.00
J1001HC-05P	4.00	6.00
J1001HC-06P	5.00	7.00
J1001HC-08P	7.00	9.00
J1001HC-09P	8.00	10.0
J1001HC-10P	9.00	11.0
J1001HC-11P	10.0	12.0
J1001HC-12P	11.0	13.0
J1001HC-13P	12.0	14.0
J1001HG-14P	13.0	15.0

						一般公差 GENERAL TOLERANCE				东莞市翰皓精密电子有限公司 Dongguan HanHao Precision Electronics Co.,Ltd				料号 PART NO J1001HC-XXP							
						. X $\pm 0.3$ . XX $\pm 0.2$ . XXX $\pm 0.1$				核准 APPD		审核 CHK		绘图 DR		日期 DATA		品名 TITLE 1.00 mm Crimp Style connectors			
2011/05/14		A	B	修改图框格式													单位 UNIT	比例 SCALE	图号 NUMBER	版次 REV	
日期 DATE	旧版次 OLD REV	新版次 NEW REV	变更内容 DESCRIPTION			审核 CHK	核准 APPD	角法	PROJECT	SUCCESS		刘艳		2007/05/03		MM	1/1	A-003	B		