

1 2 3 4 5 6 7 8

F
E
D
C
B
A

F
E
D
C
B
A

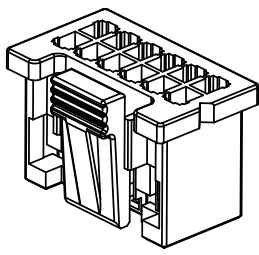
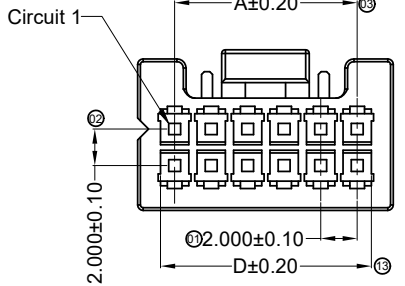

- Specifications :
- Voltage rating: 250V AC / DC
 - Current rating: 3A AC / DC
 - Withstanding voltage: 800V AC/minute
 - Temperature range: -25°C~+85°C
 - Insulation resistance: ≥1000MΩ
 - Contact resistance: ≤10mΩ
 - After environmental testing: ≤20mΩ
 - Mates With HHB Terminal: 2017T
 - Mates With HHB Wafer: 2017W

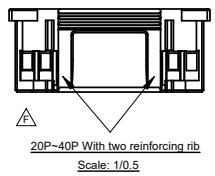
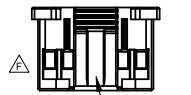
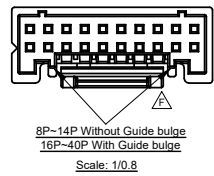
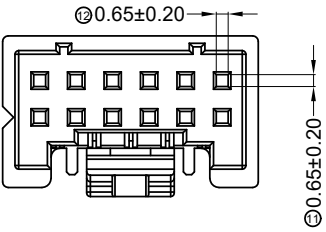
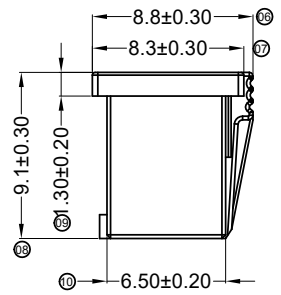
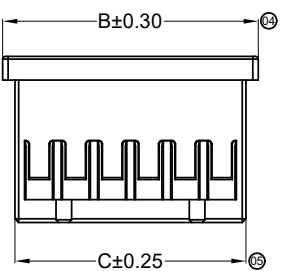

Poles	Dimensions (mm)				Poles	Dimensions (mm)			
	A	B	C	D		A	B	C	D
2*02	2.00	6.00	4.65	3.55	2*12	22.00	26.00	24.65	23.55
2*03	4.00	8.00	6.65	5.55	2*13	24.00	28.00	26.65	25.55
2*04	6.00	10.00	8.65	7.55	2*14	26.00	30.00	28.65	27.55
2*05	8.00	12.00	10.65	9.55	2*15	28.00	32.00	30.65	29.55
2*06	10.00	14.00	12.65	11.55	2*16	30.00	34.00	32.65	31.55
2*07	12.00	16.00	14.65	13.55	2*17	32.00	36.00	34.65	33.55
2*08	14.00	18.00	16.65	15.55	2*18	34.00	38.00	36.65	35.55
2*09	16.00	20.00	18.65	17.55	2*19	36.00	40.00	38.65	37.55
2*10	18.00	22.00	20.65	19.55	2*20	38.00	42.00	40.65	39.55
2*11	20.00	24.00	22.65	21.55					

2011/05/22	A	B		Modify frame format	Jova	Jova Lau
DATE	OLD REV	NEW REV	ECN	DESCRIPTION	CHECK	APPROVAL

GENERAL TOLERANCE
 .X ±0.30
 .XX ±0.20
 .XXX ±0.10

PROJECT

东莞市翰皓精密电子有限公司
 Dongguan HanHao Precision Electronics Co.,Ltd

APPROVAL	CHECK	DRAWN	DATA
Smark	Yu wei	Liu Yan	2011/05/22

PART NO. J2017H-2*XX

TITLE 2.0 mm Crimp Style Connectors

UNIT mm	SCALE 1:	NUMBER 8	REV B
---------	----------	----------	-------

1 2 3 4 5 6 7 8

1 2 3 4 5 6 7 8

F

F

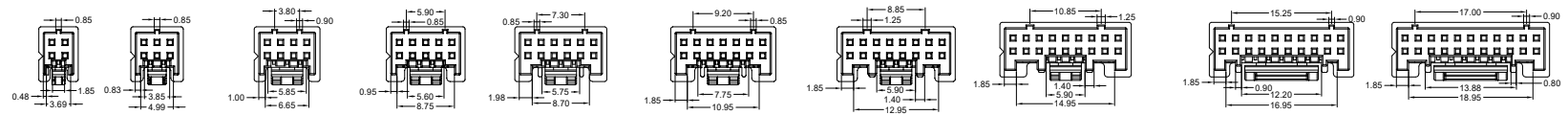

E

E

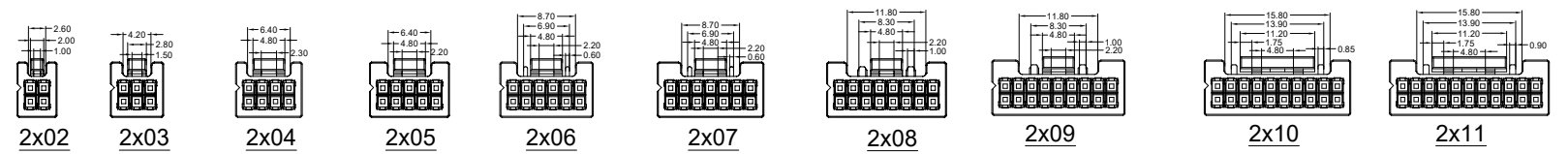

D

D

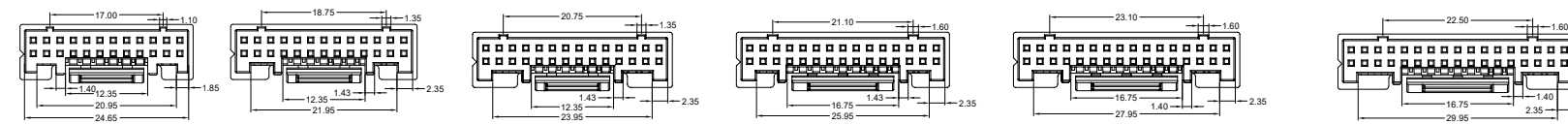

C

C

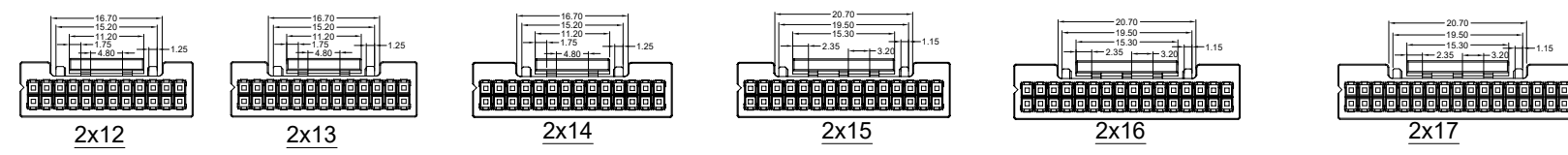

B

B

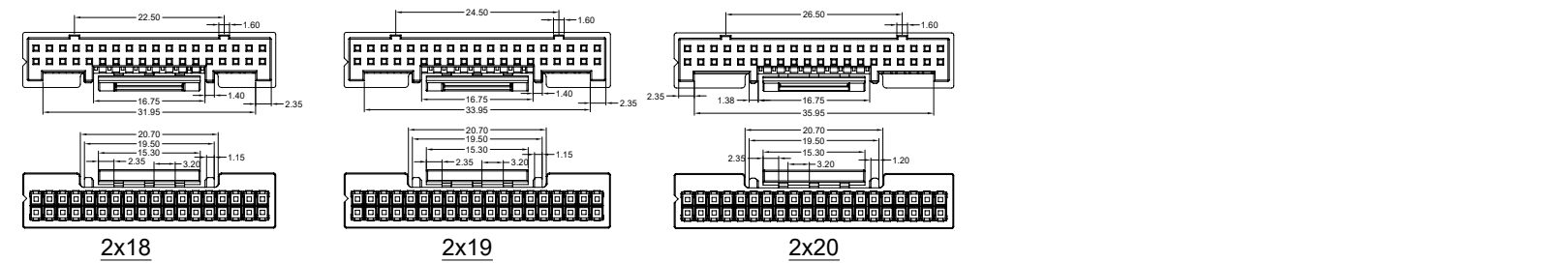

A

A

							GENERAL TOLERANCE .X ±0.30 .XX ±0.20 .XXX ±0.10				东莞市翰皓精密电子有限公司 Dongguan HanHao Precision Electronics Co.,Ltd				PART NO. J2017H-2XX			
2011/05/22				A			B				TITLE 2.0 mm Crimp Style Connectors							
DATE				OLD REV			NEW REV				ECN							
Modify frame format				Jova			Jova Lau				APPROVAL							
DESCRIPTION				CHECK			APPROVAL				Smark Yu wei Liu Yan 2011/05/22							
PROJECT											UNIT mm							
SCALE				1 :			NUMBER				REV							
8				B														

1 2 3 4 5 6 7 8

1 2 3 4 5 6 7 8

F
E
D
C
B
A

F
E
D
C
B
A

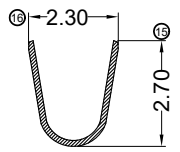
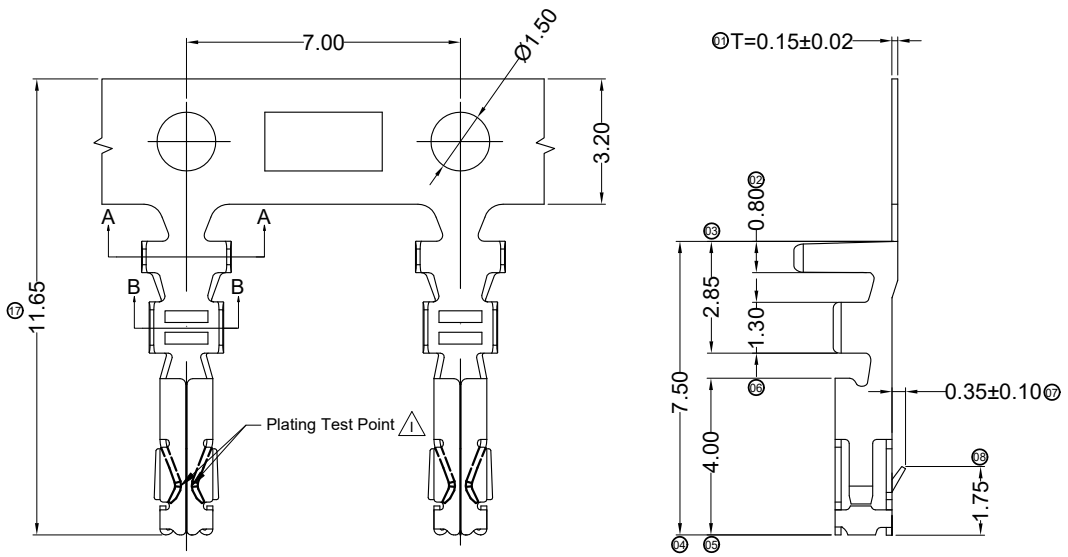

Section A-A
Scale:1:1

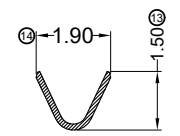
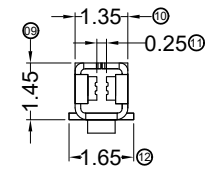

Section B-B

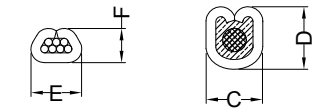

After Routing For Conductor
After Routing For Jacket

■ Specifications :

- Voltage rating: 250V AC / DC
- Current rating:
3A AC / DC Material (Phosphor bronze)
4.5A AC / DC Material (High conductivity copper)
- Withstanding voltage: 800V AC/minute
- Temperature range: -25°C~+85°C
- Insulation resistance: ≥1000MΩ
- Contact resistance: ≤10mΩ
- After environmental testing: ≤20mΩ
- Wire Range: AWG#22~AWG#28
- Insulation O.D: 1.50mm(Max)
- Mates With HHB Housing : 2017H

2011/05/22	A	B		Modify frame format	Jova	Jova Lau
DATE	OLD REV	NEW REV	ECN	DESCRIPTION	CHECK	APPROVAL

GENERAL TOLERANCE	
.X	±0.30
.XX	±0.20
.XXX	±0.10
PROJECT	

东莞市翰皓精密电子有限公司 Dongguan HanHao Precision Electronics Co.,Ltd			
APPROVAL	CHECK	DRAWN	DATA
Smark	Yu wei	Liu Yan	2011/05/22

PART NO. J2017T			
TITLE 2.0 mm Crimp Style Connectors			
UNIT mm	SCALE 1:	NUMBER 8	REV B

1 2 3 4 5 6 7 8

1 2 3 4 5 6 7 8

F

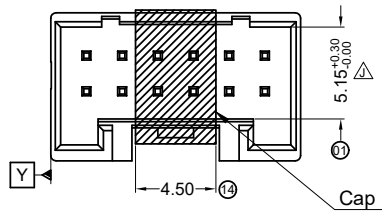

E

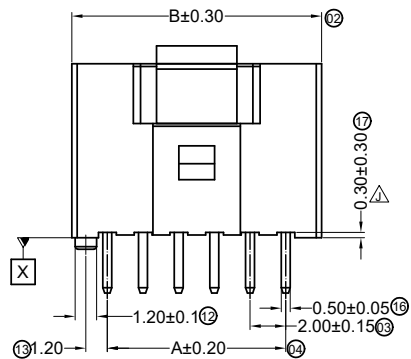

D

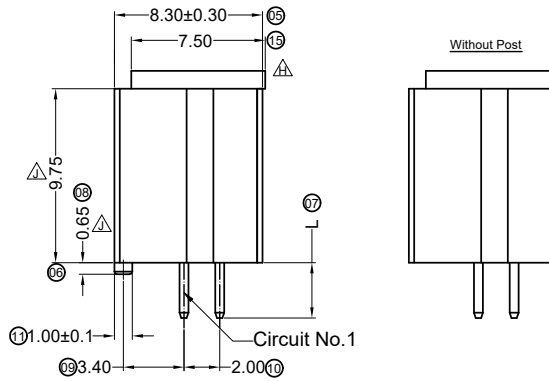

C

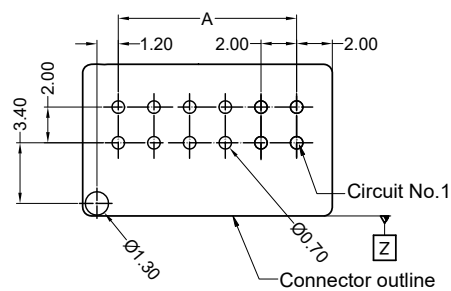

Recommended P.C.B Layout
General Tolerance±0.05

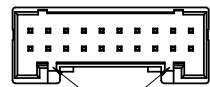
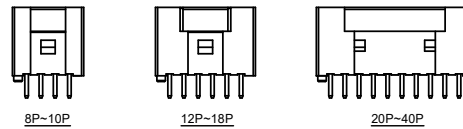

8P~14P Without Guideway
16P~40P With Guideway
Scale: 1/0.5

■ Specifications :

- Voltage rating: 250V AC / DC
- Current rating:
3.0A AC / DC Material(Pin): Brass
4.5A AC / DC Material(Pin): High conductivity copper
- Withstanding voltage: 800V AC/minute
- Temperature range: -25°C~+85°C
- Insulation resistance: ≥1000MΩ
- Contact resistance: ≤10mΩ
- After environmental testing: ≤20mΩ
- Mates With HHB Housing 2017H

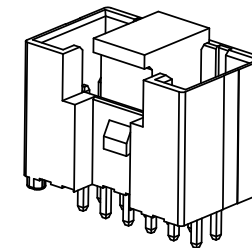

Poles	Dimensions (mm)		Poles	Dimensions (mm)	
	A	B		A	B
2*02	2.00	6.00	2*12	22.00	26.00
2*03	4.00	8.00	2*13	24.00	28.00
2*04	6.00	10.00	2*14	26.00	30.00
2*05	8.00	12.00	2*15	28.00	32.00
2*06	10.00	14.00	2*16	30.00	34.00
2*07	12.00	16.00	2*17	32.00	36.00
2*08	14.00	18.00	2*18	34.00	38.00
2*09	16.00	20.00	2*19	36.00	40.00
2*10	18.00	22.00	2*20	38.00	42.00
2*11	20.00	24.00			

A

DATE	OLD REV	NEW REV	ECN	DESCRIPTION	CHECK	APPROVAL
2011/05/22	A	B		Modify frame format	Jova	Jova Lau

GENERAL TOLERANCE

- .X ±0.30
- .XX ±0.20
- .XXX ±0.10

PROJECT



东莞市翰皓精密电子有限公司
Dongguan HanHao Precision Electronics Co.,Ltd

APPROVAL	CHECK	DRAWN	DATA
Smark	Yu wei	Liu Yan	2011/05/22

PART NO.			
J2017W-2*XX			
TITLE			
2.0 mm Crimp Style Connectors			
UNIT	SCALE	NUMBER	REV
mm	1 :	8	B

1 2 3 4 5 6 7 8

A

A

1 2 3 4 5 6 7 8

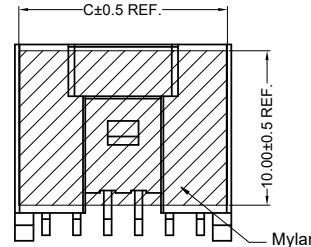
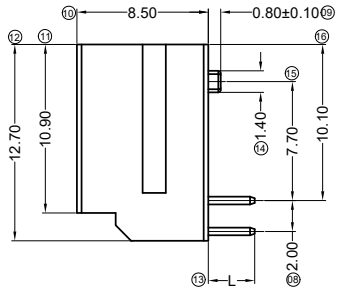
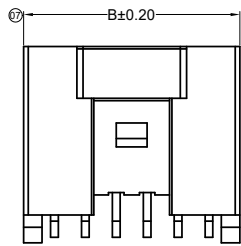
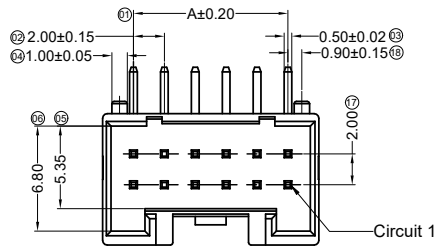

Specifications :

- Voltage rating: 250V AC / DC
- Current rating: 3A AC / DC
- Withstanding voltage: 800V AC/minute
- Temperature range: -25°C~+85°C
- Insulation resistance: ≥1000MΩ
- Contact resistance: ≤10mΩ
- After environmental testing: ≤20mΩ
- Material(Pin): Brass
- Mates With HHB Housing 2017H

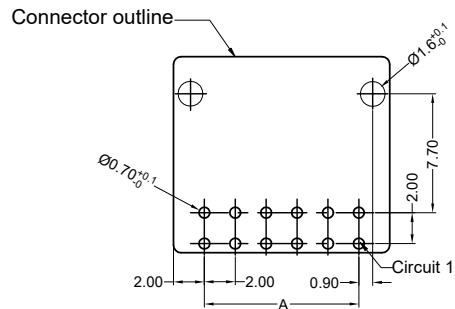
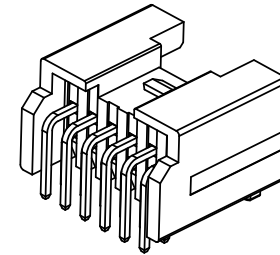

Recommended P.C.B Layout
General Tolerance±0.05

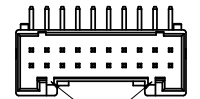
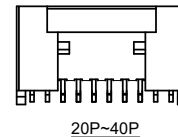
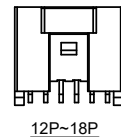
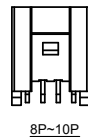
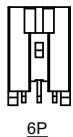

6P~14P Without Guideway
16P~40P With Guideway
Scale: 1/0.5

Poles	Dimensions (mm)			Poles	Dimensions (mm)		
	A	B	C		A	B	C
2*02	2.00	6.00	5.50	2*12	22.00	26.00	
2*03	4.00	8.00	7.50	2*13	24.00	28.00	
2*04	6.00	10.00	9.50	2*14	26.00	30.00	
2*05	8.00	12.00	11.50	2*15	28.00	32.00	
2*06	10.00	14.00	13.50	2*16	30.00	34.00	
2*07	12.00	16.00	13.50	2*17	32.00	36.00	
2*08	14.00	18.00	13.50	2*18	34.00	38.00	
2*09	16.00	20.00	13.50	2*19	36.00	40.00	
2*10	18.00	22.00		2*20	38.00	42.00	
2*11	20.00	24.00					

2011/05/22	A	B		Modify frame format	Jova	Jova Lau
DATE	OLD REV	NEW REV	ECN	DESCRIPTION	CHECK	APPROVAL

GENERAL TOLERANCE	.X ±0.30
	.XX ±0.20
	.XXX ±0.10
PROJECT	

东莞市翰皓精密电子有限公司 Dongguan HanHao Precision Electronics Co.,Ltd			
APPROVAL	CHECK	DRAWN	DATA
Smark	Yu wei	Liu Yan	2011/05/22

PART NO. J2017WR-2*XX			
TITLE 2.0 mm Crimp Style Connectors			
UNIT mm	SCALE 1:	NUMBER 8	REV B

1 2 3 4 5 6 7 8